

Apparecchi di comando - CARATTERISTICHE TECNICHE

Pulsante a targhetta luminosa

Apparecchio da alimentare per mezzo di trasformatore di sicurezza

Lampade siluro

Gamma e caratteristiche lampade siluro

Articolo	Tipo	Tensione	Potenza	Dimens.	Colore
07054.L	incand.	12 V	3 W	ø 7x37	bianco
07055.L	incand.	24 V	3 W	ø 7x37	bianco

16190 schema

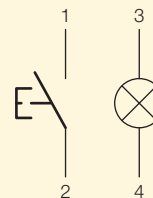

Apertura tasto targhetta

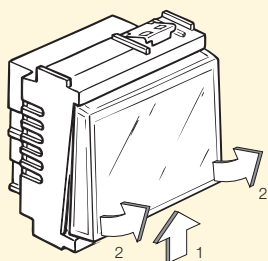

Montaggio lampada e cartoncino personalizzato

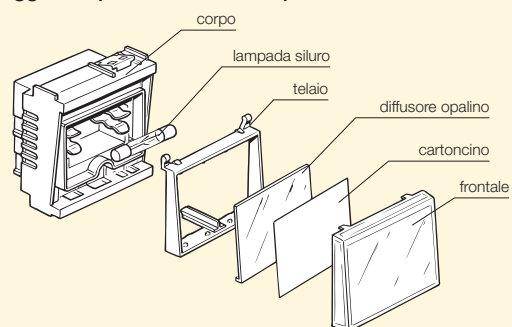

Apparecchi di comando

Pulsante unipolare in chiusura speciale

16190 .B Pulsante 1P NO 10 A 12-24 V~ (SELV), a targhetta luminosa per lampada siluro 12-24 V 3 W ø 7x37 mm - 2 moduli.
Fornito senza lampada



16190
grigio



16190.B
bianco

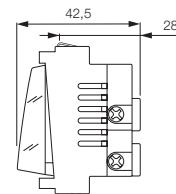

Pulsante unipolare in chiusura speciale

16083 .B Pulsante 1P NC 10 A 250 V~, a tirante, con 1,5 m cordone e pomello

16084 .B Pulsante 1P NO 10 A 250 V~, a tirante, con 1,5 m cordone e pomello



16083
16084
grigio



16083.B
16084.B
bianco

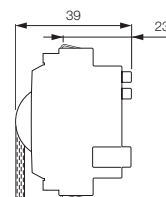

Pulsanti unipolari di manovra 250 V~

16101 .B Pulsante 1P NO (di marcia) 16 A

16104 .B Pulsante 1P NC (di arresto) 16 A

16107 .B Pulsante 1P NO (di marcia) 16 A con contatto ausiliario NC 16 A

16110 .B Pulsante 1P NC (di arresto) 16 A con contatto ausiliario NO 16 A

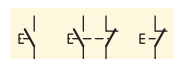

16101
grigio



16101.B
bianco



16104
grigio



16104.B
bianco

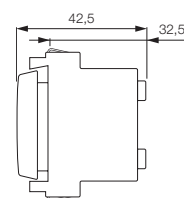

16107
grigio



16107.B
bianco



16110
grigio



16110.B
bianco

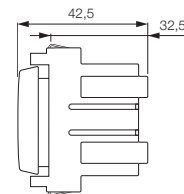

Apparecchi di comando

Invertitore unipolare 250 V~

17005 .B Invertitore 1P 16 AX



Caratteristiche tecniche pag. 120-122



17005
grigio



17005.B
bianco

Pulsanti unipolari in chiusura

17010 .B Pulsante 1P NO 10 A 250 V~, generico

17010.G .B Pulsante 1P NO 10 A 250 V~, generico - 2 moduli ridotti

Δ 17010.F .B Pulsante 1P NO 10 A 250 V~, generico, con indicatore luminescente



a Caratteristiche tecniche pag. 124



17010
grigio



17010.B
bianco



17010.G
grigio



17010.G.B
bianco



17010.F
grigio



17010.F.B
bianco

Pulsanti unipolari in chiusura

17010.L .B Pulsante 1P NO 10 A 250 V~, luminoso, per unità di segnalazione. Fornito senza unità di segnalazione

17020 .B Pulsante 1P NO 10 A 12-24 V~ (SELV), a targhetta luminosa per lampada siluro 12-24 V 3 W ø 7x37 mm - 2 moduli ridotti. Fornito senza lampada



Caratteristiche tecniche pag. 124-128



17010.L
grigio



17010.L.B
bianco



17020
grigio



17020.B
bianco